

90 PLUS HEATING STOVE - OVEN ON RIGHT

Technical data (Data may vary depending on type of fuel used)

Fuel	Wood
Energy class	A+
Water volume in boiler	23 l
Heating capacity	15 - 22 kW / 12900 - 18920 Kcal
Heating capacity H ₂ O	8 - 15 kW / 6880 - 12900 Kcal
Performance	86.5 %
Diameter smoke outlet	Ø 150 mm
Minimum draught	15 Pa / 0.15 mbar
Temperature smoke outlet	180 °C
Smoke mass	17 g/s
CO at 13% O ₂	0.07 %
Weight	250 kg
Optional chimney outlets	5
Maximum water pressure	3 bar
Maximum operating pressure	95 °C
Power voltage	230 / 12V - 50 / 60Hz
Test report	C-1076393-1
VKF AEA1 - No.	23647
Firebox opening (B x H)	210 x 230 mm
Firebox measurements (L x D x H)	270 x 380 x 290 - 420 mm
Drawer measurements (L x D x H)	300 x 420 x 160 mm
Oven (L x D x H)	345 x 420 x 265 mm
Cooking hob (L x D)	800 x 500 mm
External air intake	Ø 80 mm
CO at 13% O ₂ (Carbon monoxide) / NO _x (Nitrogen oxide)	893.0 mg/Nm ³ / 117.0 mg/MJ
Dust / OGC (Organic compounds)	28.0 mg/Nm ³ / 38.0 mg/MJ

WARNING: Minimum safety distance from flammable materials

From the rear and side connection to the chimney * 40mm of insulation with heat conductivity equal to 0.07 W/mK at 200°C	P= 0 + 40* mm Following agreement with chimney sweep
On the side above the plate	L= 400 mm
On the side below the plate	L= 3 mm
Above the plate	Min. 750 mm
In the front from the middle of the fire door	R= 250 mm
Plate for floor protection	Based on specific country directives



To operate the electronic control unit and the oven light, install two Schuko sockets either a) behind the wood drawer at a maximum height of 270mm from the floor, or b) at a maximum distance from the kitchen stove of 500 mm

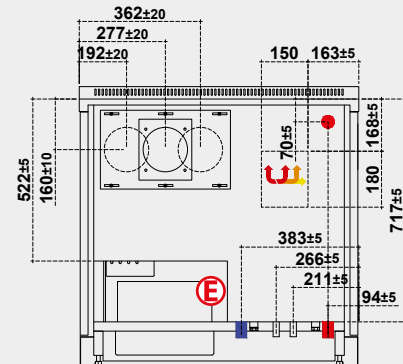
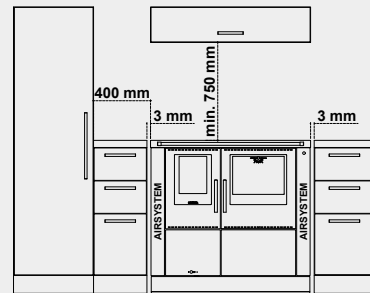
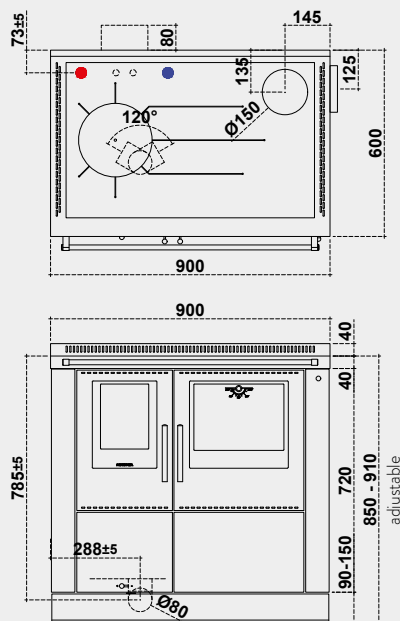
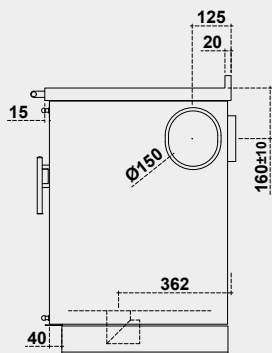

Ein Unternehmen aus
südtirol

90 PLUS HEATING STOVE - OVEN ON LEFT

Technical data (Data may vary depending on type of fuel used)

Fuel	Wood
Energy class	A+
Water volume in boiler	23 l
Heating capacity	15 - 22 kW / 12900 - 18920 Kcal
Heating capacity H ₂ O	8 - 15 kW / 6880 - 12900 Kcal
Performance	86.5 %
Diameter smoke outlet	Ø 150 mm
Minimum draught	15 Pa / 0.15 mbar
Temperature smoke outlet	180 °C
Smoke mass	17 g/s
CO at 13% O ₂	0.07 %
Weight	250 kg
Optional chimney outlets	5
Maximum water pressure	3 bar
Maximum operating pressure	95 °C
Power voltage	230 / 12V - 50 / 60Hz
Test report	C-1076393-1
VKF AEA1 - No.	23647
Firebox opening (B x H)	210 x 230 mm
Firebox measurements (L x D x H)	270 x 380 x 290 - 420 mm
Drawer measurements (L x D x H)	300 x 420 x 160 mm
Oven (L x D x H)	345 x 420 x 265 mm
Cooking hob (L x D)	800 x 500 mm
External air intake	Ø 80 mm
CO at 13% O ₂ (Carbon monoxide) / NO _x (Nitrogen oxide)	893.0 mg/Nm ³ / 117.0 mg/MJ
Dust / OGC (Organic compounds)	28.0 mg/Nm ³ / 38.0 mg/MJ

WARNING: Minimum safety distance from flammable materials

From the rear and side connection to the chimney
* 40mm of insulation with heat conductivity equal to 0.07 W/mK at 200°C

On the side above the plate	P= 0 + 40* mm Following agreement with chimney sweep
On the side below the plate	L= 400 mm
Above the plate	L= 3 mm
In the front from the middle of the fire door	Min. 750 mm
Plate for floor protection	R= 250 mm
	Based on specific country directives



To operate the electronic control unit and the oven light, install two Schuko sockets either a) behind the wood drawer at a maximum height of 270mm from the floor, or b) at a maximum distance from the kitchen stove of 500 mm

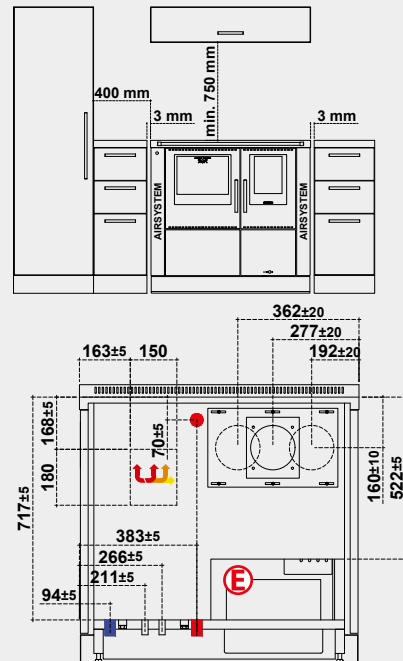
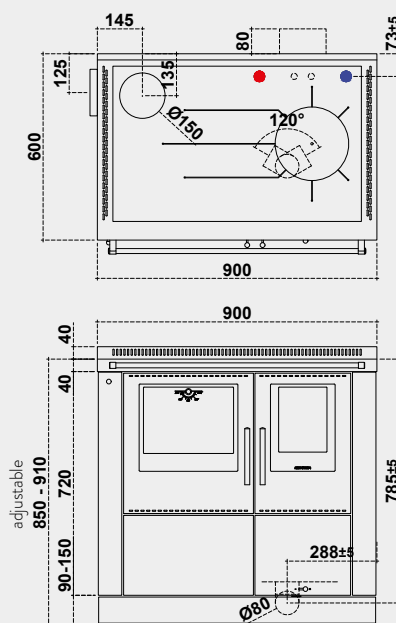
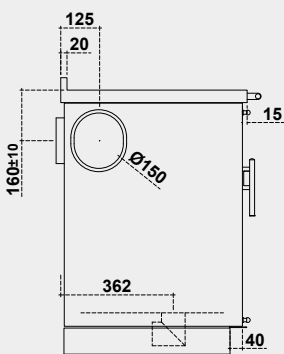

Ein Unternehmen aus
südtirol